

A Model for COVID-19 with Limited Vaccination

Glenn Ledder

Department of Mathematics
University of Nebraska-Lincoln
gledder@unl.edu

June 14, 2021

Aim of the Research

- ▶ Study the impact of key interacting factors:
 - social distancing and mask use
 - *testing [included, but not studied in this talk]*
 - vaccination distribution rate
 - vaccination efficacy
 - vaccination acceptance

Key Requirements Beyond SEIR

- ▶ Multiple Infectious Classes:
 - Symptomatic
 - Asymptomatic
 - shorter duration, lower infectivity, no testing
 - Hospitalized
 - possible mortality, no infectivity
- ▶ Multiple Interventions
 - Masks and Physical Distancing
 - reduced infectivity for unconfirmed cases
 - Testing and Isolation
 - reduced infectivity for confirmed cases
 - Vaccination (*infection-blocking and/or disease-blocking*)
 - not everyone accepts, not always effective
 - limited supply

The PSEAIHRD Model (expanded SEIR)

- ▶ Susceptible Classes
 - Pre-vaccinated
 - Susceptible
- ▶ Exposed (latent) Classes
 - Exposed
- ▶ Infectious Classes
 - Asymptomatic
 - Infectious (symptomatic)
 - Hospitalized
- ▶ Removed Classes
 - Recovered (or vaccinated)
 - Deceased

The PSEAIHRD Model

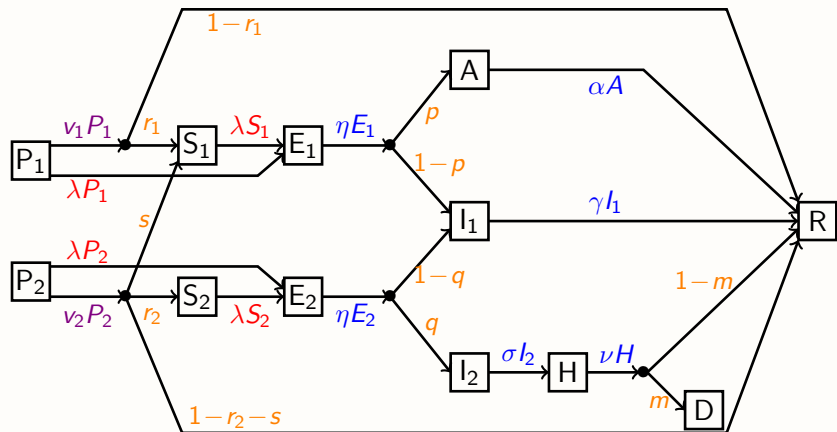

transitions, transmissions, vaccination, divergent paths

The PSEAIHRD Model – Transitions

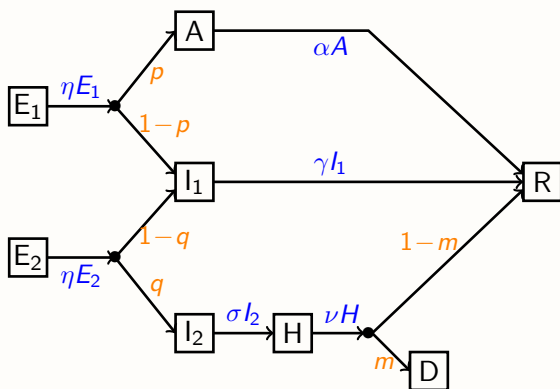

The PSEAIHRD Model – Transmissions

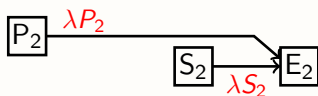

$$\lambda = \beta X, \quad X = f_c(p_c I + p_{ca} A) + \delta[(1 - p_c)I + f_a(1 - p_{ca})A].$$

- ▶ p_c and p_{ca} are the fractions of confirmed cases for symptomatic and asymptomatic infectives.
- ▶ f_c , f_a are the infectivities of confirmed cases, and asymptomatic cases, relative to an unconfirmed symptomatic infective.
- ▶ δ is a 'contact factor' that incorporates physical distancing and mask use for unconfirmed cases.

The PSEAIHRD Model – Vaccination

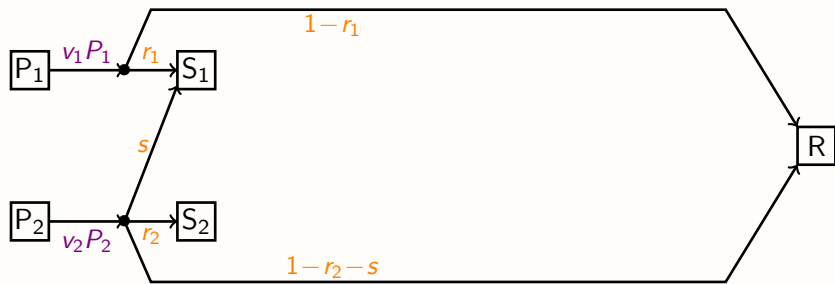

- ▶ r_i are the probabilities of vaccine failure.
- ▶ s is the probability that the vaccine fails to stop infection.
- ▶ v_i are rate 'constants' that depend on the status of the vaccination program.

Two-Class Vaccination Model

- ▶ Suppose a fraction τ of W is high-risk.

$$W_2(0) = \tau W_0, \quad W_1(0) = (1 - \tau)W_0.$$

- ▶ Assume the same model for high-risk as for the whole group.

$$W_2' = -\frac{V}{K + W_2} W_2 \equiv -v(W_2)W_2, \quad v(W_2) = \frac{V}{K + W_2}.$$

- Then

$$W_1' = W' - W_2' = \dots = -u(W)v(W_2)W_1, \quad u(W) = \frac{K}{K + W}.$$

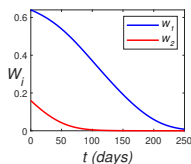
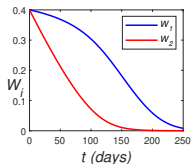

PSEAIHRD Vaccination Details

- ▶ We need v_i for

$$P_i' = -v_i P_i - \lambda P_i.$$

- ▶ We have

$$W_1' = -u(W)v(W_2)W_1, \quad W_2' = -v(W_2)W_2,$$

$$v(W_2) = \frac{V}{K + W_2}, \quad u(W) = \frac{K}{K + W}.$$

- ▶ Therefore

$$v_2 = v(W_2), \quad v_1 = u(W)v(W_2).$$

- ▶ We need only couple the W and W_2 equations to the PSEAIHRD system.

Key Fixed Parameter Values

- ▶ Types of Cases (pre-vaccination):
 - 60% of cases symptomatic
 - 20% of cases confirmed
 - 8% of confirmed cases require hospitalization (1.6% of total)
 - 25% mortality for hospitalized patients (0.4% of total)
- ▶ Initial State
 - 20% of the population is at high risk.
 - 60% of people initially susceptible (S and P)
 - Infectious classes calculated from assumption of 4000 US deaths per day.
- ▶ Vaccination Parameters
 - maximum rate $V = 0.005$

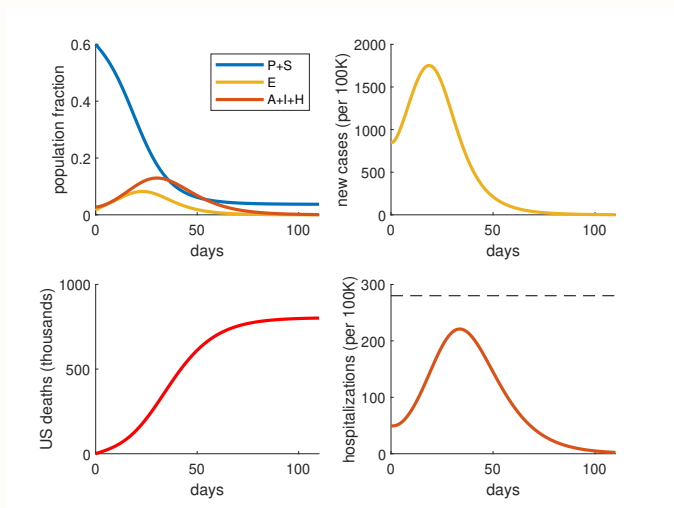
Base Scenario: $\delta = 1$, $V = 0$, $\mathcal{R}_0 = 6$ 

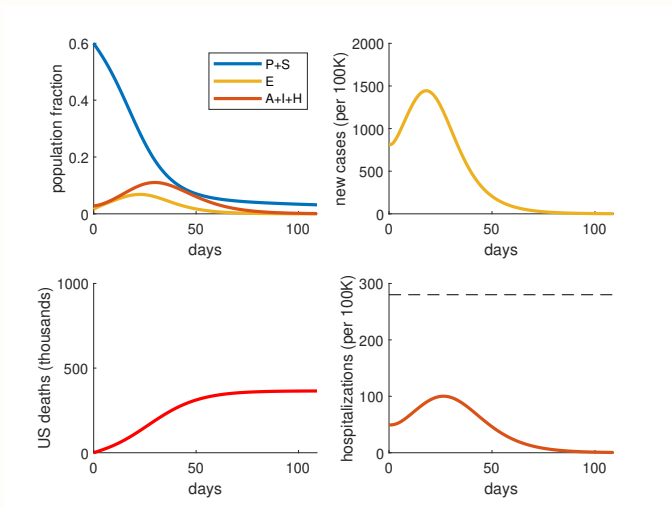
Vaccination Scenario: $\delta = 1$, $V = 0.005$, $\mathcal{R}_0 = 6$ 

$V = 0.005$; $\delta = 1, 0.8, 0.6, 0.4, 0.2$ (bl.-gr., gold default)

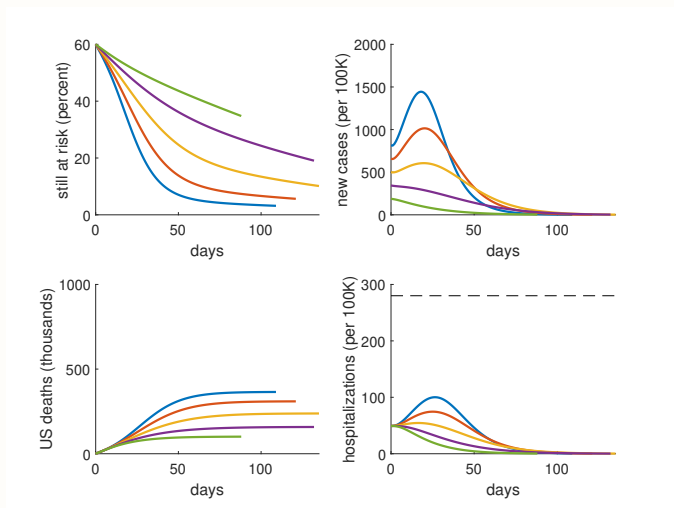

D_∞ vs V ; $\delta = 1, 0.8, 0.6, 0.4, 0.2$ (bl-gr)

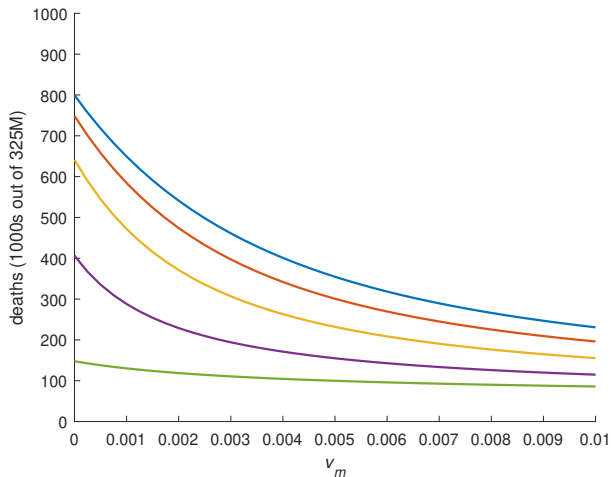

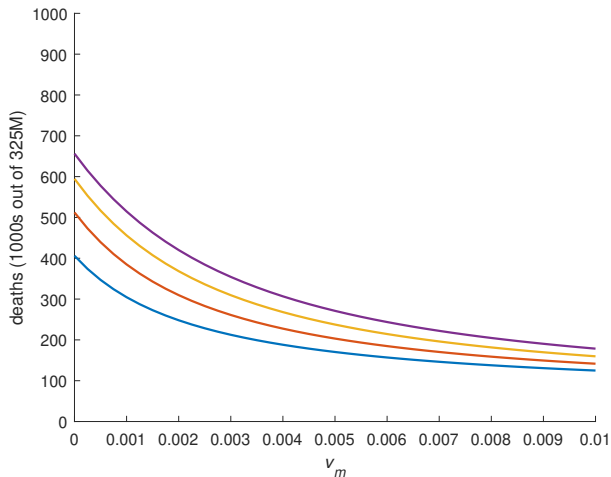
D_∞ vs V ; $R_0 = 6, 7, 8, 9$ (bl-vi)

Parameters That Matter Less

- ▶ The vaccine failure fraction r only matters if it is more than 30%.
- ▶ The partial failure fraction s does not matter.
- ▶ The dissension fraction d only matters if it is more than 50%.
 - Our scenarios assume 40% are already immune.

Resources

- ▶ See <https://www.math.unl.edu/SIR-modeling> for
 - Details on a classroom activity, including directions for an online implementation;
 - SIR and SEIR teaching modules using Excel and Matlab;
 - Links to some useful resources.
- ▶ See <https://www.math.unl.edu/covid-module> for COVID-19 teaching modules.
- ▶ Ledder and Homp, Using a COVID-19 model in various classroom settings to assess effects of interventions, PRIMUS 2021
<https://www.tandfonline.com/doi/full/10.1080/10511970.2020.1861143>
- ▶ **Shoot me an email to receive updates or offer feedback!**
gledder@unl.edu